

Downee

BLACK HARDWARE

GATE & FENCE

**Powder Coated Parts
Price List**

Introducing Black Hardware



AUSTRALIAN MADE

Downee has been making steel hardware since 1928. Most products shown in this brochure are made in Australia by Downee using local materials and suppliers.



SAME DAY DESPATCH

Items are shown as:
In Stock ready for despatch for orders before 2pm.
To Order products are supplied in box quantities with a 2-week lead time.



INTRO PRICING

To kick things off we're offering special prices on all Black powder coated products. Prices shown are List prices.

INDEX

Tees	4	Tube Hinges	15
Crosses	5	Pipe Hinges	16
Adjustable Corners	6	Latches & Catches	18
Universal Fittings	7	All Finishes	19
Cage Spigots	9	Items in this brochure are available in other finishes.	
Cage Builder	10	Pipe Size Converter	22
Round Caps	11	Contact Us	23
Square Caps	12		
Rail Brackets	13		
Adjustable Rail Bracket	14		



The products in these pages represent only a small part of our range. If your favourite parts aren't shown, call us to discuss a custom order.

Black products are powder coated over the regular corrosion resistant finish.

Please note that where loose Bolts and Nuts are included with the item they are **not** supplied as powder coated.

All prices are in AUD and exclude GST.

BLACK TEE

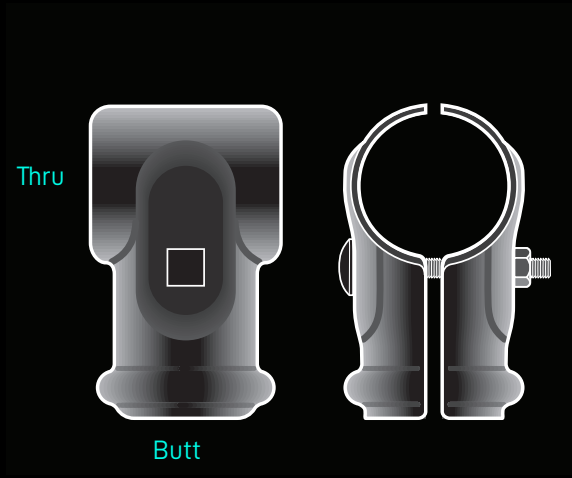

MODEL TEE

FINISH GALVANISED + BLACK POWDER COAT

CODE	THRU (NB)	BUTT (NB)	CTN QTY	LIST PRICE	AVAILABILITY
T2525-C	25	25	50	\$7.04	To Order
T2532-C	25	32	40	\$8.56	In Stock
T2540-C	25	40	30	\$9.53	To Order
T3225-C	32	25	40	\$8.32	To Order
T3232-C	32	32	40	\$8.81	In Stock
T3240-C	32	40	20	\$10.00	In Stock
T3250-C	32	50	20	\$13.00	In Stock
T4025-C	40	25	40	\$9.53	To Order
T4032-C	40	32	30	\$9.77	In Stock
T4040-C	40	40	20	\$11.00	In Stock
T4050-C	40	50	10	\$13.78	In Stock
T5025-C	50	25	30	\$12.00	In Stock
T5032-C	50	32	30	\$12.82	In Stock
T5040-C	50	40	20	\$15.00	In Stock
T5050-C	50	50	10	\$16.00	In Stock
T8025-C	80	25	10	\$16.00	To Order
T8032-C	80	32	10	\$16.73	In Stock
T8040-C	80	40	10	\$18.72	In Stock
T8050-C	80	50	10	\$24.00	To Order

BLACK CROSS

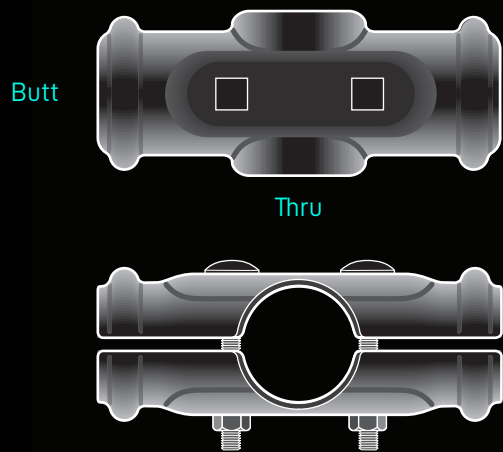

MODEL CROSS

FINISH GALVANISED + BLACK POWDER COAT

CODE	BUTT (NB)	THRU (NB)	CTN QTY	LIST PRICE	AVAILABILITY
X2525-C	25	25	30	\$11.00	To Order
X2532-C	25	32	20	\$11.57	In Stock
X2540-C	25	40	30	\$12.00	In Stock
X2550-C	25	50	20	\$15.00	In Stock
X3232-C	32	32	20	\$13.00	In Stock
X3240-C	32	40	20	\$13.66	In Stock
X3250-C	32	50	10	\$14.00	In Stock
X4040-C	40	40	20	\$14.57	In Stock
X4050-C	40	50	10	\$17.00	In Stock
X5050-C	50	50	10	\$28.00	In Stock

BLACK CORNER

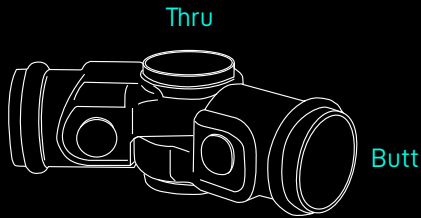
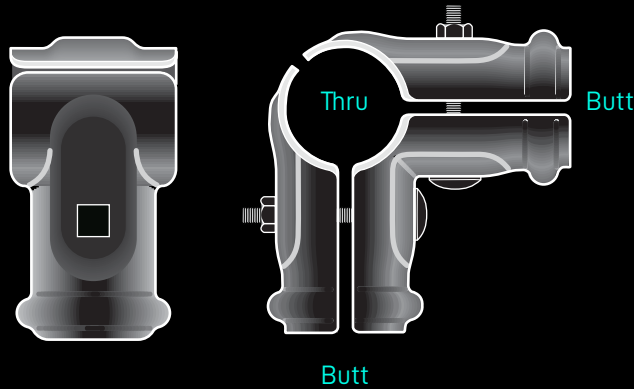

MODEL CORNER

FINISH GALVANISED + BLACK POWDER COAT

CODE	BUTT (NB)	THRU (NB)	CTN QTY	LIST PRICE	AVAILABILITY
C2525-C	25	25	30	\$15.60	To Order
C2532-C	25	32	20	\$13.98	To Order
C2540-C	25	40	20	\$17.00	To Order
C2550-C	25	50	20	\$20.53	To Order
C3232-C	32	32	20	\$19.79	In Stock
C3240-C	32	40	10	\$20.00	To Order
C3250-C	32	50	10	\$21.00	In Stock
C4040-C	40	40	10	\$23.00	In Stock
C4050-C	40	50	10	\$24.00	In Stock

MODEL ADJUSTABLE CORNER

FINISH GALVANISED + BLACK POWDER COAT

CODE	BUTT (NB)	THRU (NB)	CTN QTY	LIST PRICE	AVAILABILITY
AC3232-C	32	32	15	\$26.00	To Order
AC3240-C	32	40	15	\$26.00	In Stock
AC3250-C	32	50	15	\$29.00	In Stock
AC4040-C	40	40	15	\$27.00	In Stock
AC4050-C	40	50	15	\$30.00	In Stock
AC5050-C	50	50	10	\$41.00	To Order

BLACK UNIVERSAL

30°-150° vertical adjustment

when mounted to a Post Clamp
or Clamp Connector.

Variable corner angle, fixed
vertical angle

Rail Clamps & Post Clamps
sizes are interchangeable

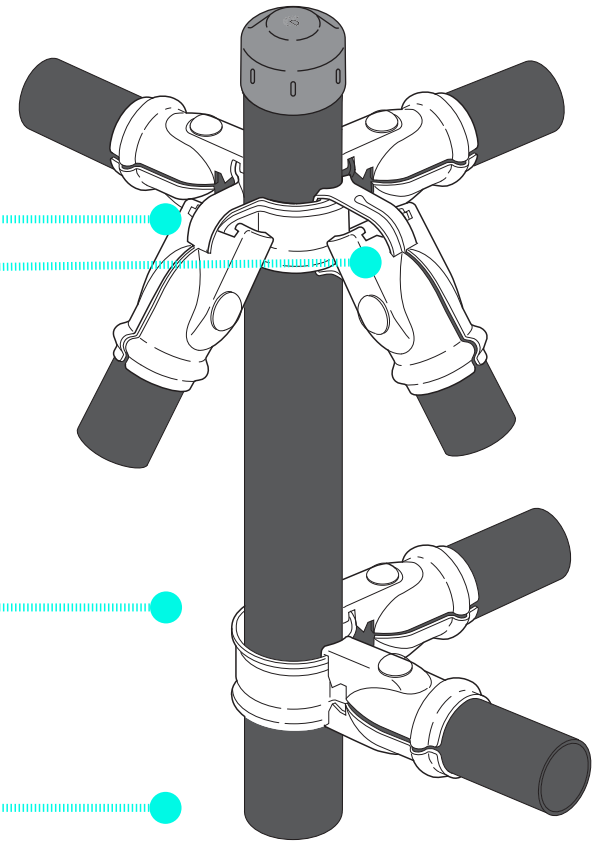

BLACK UNIVERSAL

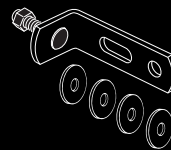
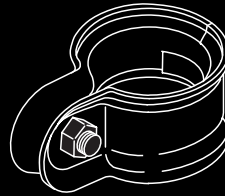
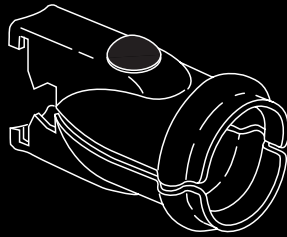

MODEL UNIVERSAL RAIL CLAMP FINISH GALVANISED + BLACK POWDER COAT

CODE	BUTT (NB)	CTN QTY	LIST PRICE	AVAILABILITY
UFFB25-C	25	40	\$9.55	In Stock
UFFB32-C	32	30	\$9.89	In Stock
UFFB40-C	40	30	\$10.83	In Stock
UFFB50-C	50	20	\$13.55	In Stock

MODEL UNIVERSAL POST CLAMP FINISH GALVANISED + BLACK POWDER COAT

CODE	THRU (NB)	CTN QTY	LIST PRICE	AVAILABILITY
UFFT25-C	25	50	\$8.23	In Stock
UFFT32-C	32	40	\$9.85	In Stock
UFFT40-C	40	40	\$8.72	In Stock
UFFT50-C	50	40	\$9.44	In Stock
UFFT65-C	65	30	\$13.00	In Stock
UFFT80-C	80	20	\$14.00	In Stock
UFFT100-C	100	20	\$15.00	In Stock
UFFT150-C	150	10	\$16.00	In Stock

MODEL UNIVERSAL CLAMP CONNECTOR FINISH GALVANISED + BLACK POWDER COAT

CODE	CTN QTY	LIST PRICE	AVAILABILITY
UFFMPC-C	100	\$5.90	In Stock

Multi-fit connector compatible with all post and rail clamp sizes.

MODEL UNIVERSAL WALL BRACKET FINISH GALVANISED + BLACK POWDER COAT

CODE	CTN QTY	LIST PRICE	AVAILABILITY
UFFWB-C	50	\$15.40	In Stock

Used with UFFB and UFFT (all combinations) to secure fittings to a wall. Provides easy access for wire lacing.

BLACK CAGE SPIGOT

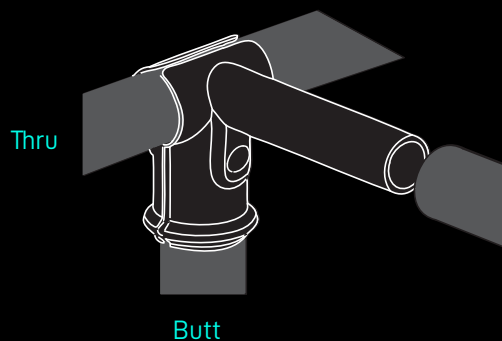
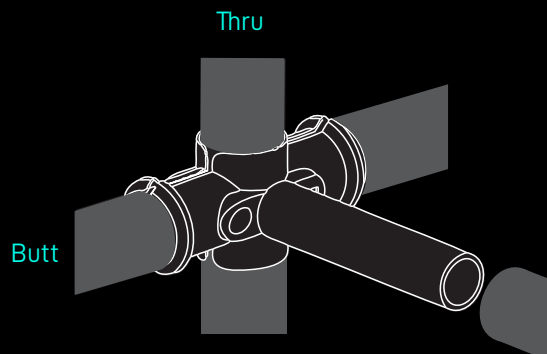

MODEL CROSS SPIGOT

FINISH GALVANISED + BLACK POWDER COAT

CODE	BUTT (NB)	THRU (NB)	CTN QTY	LIST PRICE	AVAILABILITY
X3240-SPIGOT-C	32	40	20	\$19.76	In Stock

MODEL TEE SPIGOT

FINISH GALVANISED + BLACK POWDER COAT

CODE	THRU (NB)	BUTT (NB)	CTN QTY	LIST PRICE	AVAILABILITY
T3240-SPIGOT-C	40	32	20	\$12.42	In Stock
T4032-SPIGOT-C	32	40	20	\$12.42	In Stock

CAGE BUILDER

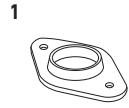

Oval Flange
F32R
F40R



Tee Spigot
T2532-SPIGOT
T3240-SPIGOT

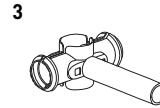

Cross Spigot
X2532-SPIGOT
X3240-SPIGOT

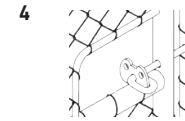

Gate Brace & Shoot Bolt
GEB11

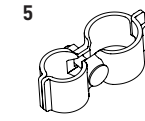

Clamp-on Hinge
TH3225
TH4025

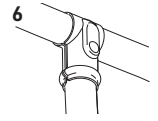

Tee
T3225
T4032

- TEE
- TEE SPIGOT
- CROSS SPIGOT

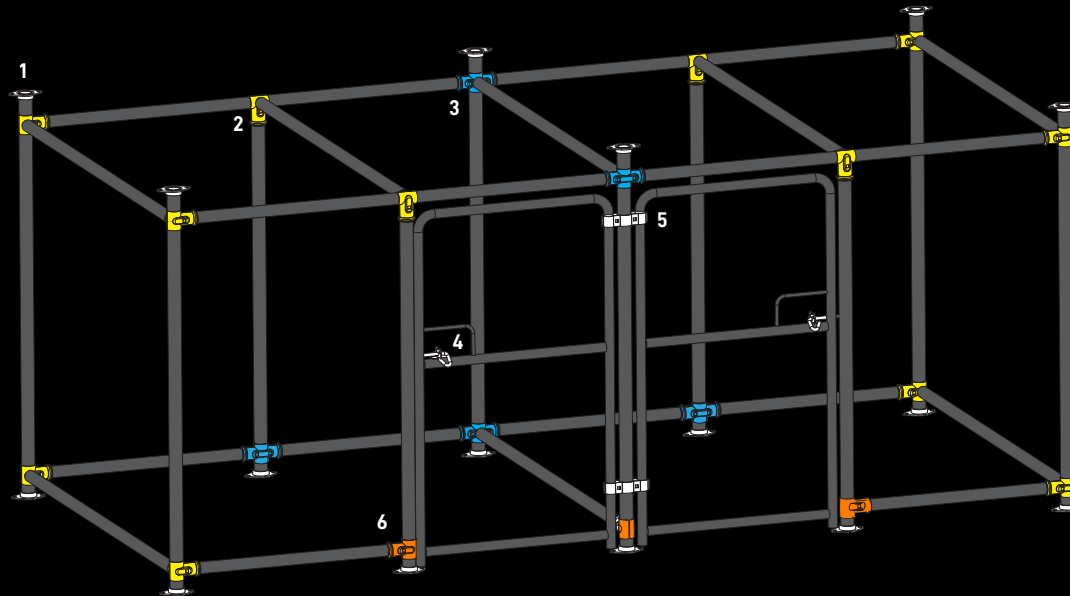

BLACK ROUND CAP

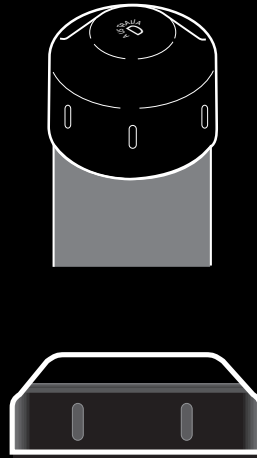

MODEL ROUND STEEL CAP FINISH GALVANISED + BLACK POWDER COAT

CODE	PIPE (NB)	CTN QTY	LIST PRICE	AVAILABILITY
K20-C	20	200	\$3.80	To Order
K25-C	25	150	\$4.36	To Order
K32-C	32	100	\$4.43	In Stock
K40-C	40	80	\$4.54	In Stock
K50-C	50	50	\$4.90	In Stock
K65-C	65	30	\$6.52	In Stock
K80-C	80	20	\$6.80	In Stock
K100-C	100	20	\$10.00	In Stock

MODEL ROUND STEEL CAP FINISH GALVABOND + BLACK POWDER COAT

CODE	PIPE (NB)	CTN QTY	LIST PRICE	AVAILABILITY
K20GB-C	20	300	\$3.00	In Stock
K25GB-C	25	150	\$3.35	In Stock
K32GB-C	32	100	\$3.40	In Stock
K40GB-C	40	80	\$3.95	In Stock
K50GB-C	50	50	\$3.99	In Stock
K65GB-C	65	30	\$4.58	In Stock
K80GB-C	80	40	\$6.50	In Stock
K100GB-C	100	20	\$8.00	In Stock
K125GB-C	125	20	\$10.50	To Order
K150GB-C	150	10	\$10.65	To Order

BLACK SQUARE CAP

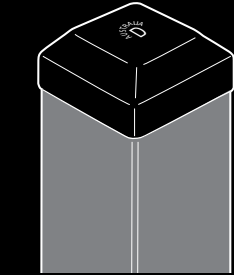

MODEL STEEL DOMED SQUARE CAP FINISH GALVABOND + BLACK POWDER COAT

CODE	TUBE	CTN QTY	LIST PRICE	AVAILABILITY
K50MSGB-C	50x50	100	\$4.00	In Stock
K65MSGB-C	65x65	50	\$4.80	In Stock
K75MSGB-C	75x75	60	\$6.10	In Stock
K90MSGB-C	90x90	20	\$7.35	In Stock
K100MSGB-C	100x100	30	\$8.30	In Stock
K125MSGB-C	125x125	30	\$14.20	To Order
K150MSGB-C	150x150	20	\$15.00	To Order

MODEL CAST ALUMINIUM DOMED SQUARE CAP FINISH BLACK POWDER COAT

CODE	TUBE	CTN QTY	LIST PRICE	AVAILABILITY
PC5-C	50x50	100	\$5.71	In Stock
PC6-C	65x65	100	\$5.72	In Stock

BLACK RAIL BRACKET



MODEL STEEL RAIL BRACKET - DOUBLE LUG FINISH ZINC PLATED + BLACK POWDER COAT

CODE	RAIL	HOLES	CTN QTY	LIST PRICE	AVAILABILITY
DFB4040-2DZ-C	40x40	2 diag.	100	\$4.55	In Stock
DFB3825-2DZ-C	38x25	2 diag.	100	\$4.55	In Stock



MODEL STEEL RAIL BRACKET - SINGLE LUG FINISH ZINC PLATED + BLACK POWDER COAT

CODE	RAIL	HOLES	CTN QTY	LIST PRICE	AVAILABILITY
RFB3825-2Z-C	38x25	2	100	\$4.57	In Stock



FB38H-C
Horizontal adjustment



FB38V-C
Vertical adjustment

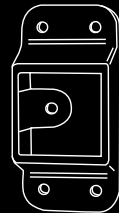

FB50PDL-C
Security fixed

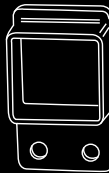

FB38PB - FB40PB
Straight fit

MODEL CAST ALUMINIUM RAIL BRACKET FINISH BLACK POWDER COAT

CODE	RAIL	HOLES	CTN QTY	LIST PRICE	AVAILABILITY
FB38H-C	38x25	2	120	\$4.47	In Stock
FB38V-C	38x25	2	120	\$4.47	In Stock
FB38PB	38x25	2	90	\$4.47	In Stock
FB40PB	40x40	2	80	\$5.00	In Stock
FB50PDL-C	50x50	4	25	\$11.00	In Stock

BLACK ADJUSTABLE RAIL

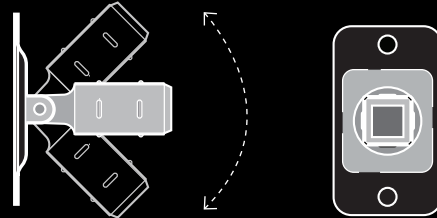
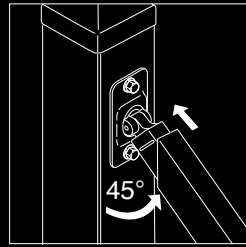

Adjusts to 45°
Rotates for horizontal or vertical adjustment

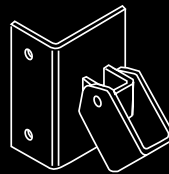

SRBA628-92-C

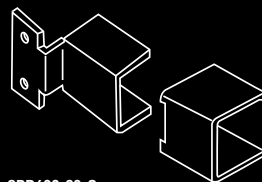
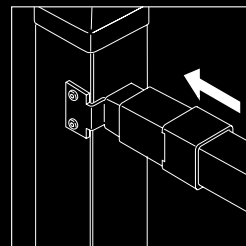

SRB620-92-C
with CUSMS-C

MODEL ADJUSTABLE RAIL BRACKET FINISH BLACK POWDER COAT

CODE	RAIL	HOLES	CTN QTY	LIST PRICE	AVAILABILITY
RBA2525-C	25x25*	2	50	\$10.86	In Stock

* Supplied with Click-Fit Adapters. See below.

MODEL CLICK-FIT ADAPTER

CODE	RAIL	CTN QTY	LIST PRICE	AVAILABILITY
AD3030	30 x 30 x 1.2-1.6	100	\$2.33	In Stock
AD3825	38 x 25 x 1.2-1.6	100	\$2.33	In Stock
AD4040	40 x 40 x 1.2-1.6	100	\$2.33	In Stock

Click-fit Adapters not shown.

MODEL SECURITY RAIL BRACKET FINISH GALVANISED + BLACK POWDER COAT

CODE	RAIL	CTN QTY	LIST PRICE	AVAILABILITY
SRBA628-92-C	40 x 40	50	\$20.50	In Stock
SRB620-92-C	40 x 40	50	\$5.30	In Stock
CUSMS-C	40 x 40	200	\$4.81	In Stock

* Security brackets attach to posts using pop rivets

BLACK TUBE HINGES

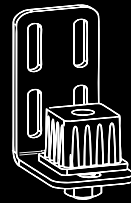
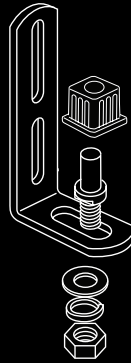
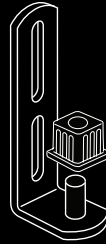

MODEL MULTI-FIT GATE HINGE FINISH ZINC PLATED + BLACK POWDER COAT

CODE	TUBE	CTN QTY	LIST PRICE	AVAILABILITY
TGP100-C	25 to 38*	50	\$10.50	In Stock

* Bushes included for 3 tube sizes:
25x25x1.2, 30x30x1.2 & 38x25x1.2

MODEL MULTI-FIT GATE HINGE - ADJUSTABLE FINISH ZINC PLATED + BLACK POWDER COAT

CODE	TUBE	CTN QTY	LIST PRICE	AVAILABILITY
TGP110-C	25 to 38*	50	\$12.00	In Stock

* Bushes included for 3 tube sizes:
25x25x1.2, 30x30x1.2 & 38x25x1.2

MODEL HEAVY-DUTY HINGE FINISH ZINC PLATED + BLACK POWDER COAT

CODE	TUBE	CTN QTY	LIST PRICE	AVAILABILITY
LBGA40-C	40x40	20	\$34.00 (pair)	In Stock

BLACK PIPE HINGES

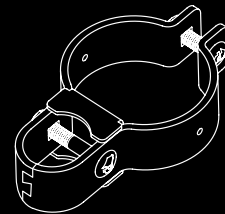
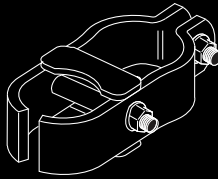
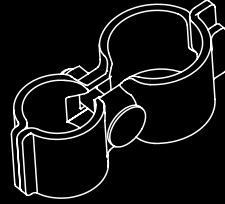

MODEL CLAMP-ON HINGE FINISH GALVANISED + BLACK POWDER COAT

CODE	POST (NB)	GATE (NB)	CTN QTY	LIST PRICE	AVAILABILITY
H3225-C	32	25	20	\$15.00	In Stock
H4020-C	40	20	20	\$15.00	To Order

MODEL TWO-PART HINGE FINISH GALVANISED + BLK POWDER COAT

CODE	POST (NB)	GATE (NB)	CTN QTY	LIST PRICE	AVAILABILITY
H4025-C	40	25	20	\$16.00	In Stock
H4032-C	40	32	20	\$18.60	To Order
H5032-C	50	32	20	\$19.50	In Stock

MODEL TWO-PART INTERLOCKING HINGE FINISH GALVANISED + BLACK POWDER COAT

CODE	POST (NB)	GATE (NB)	CTN QTY	LIST PRICE	AVAILABILITY
H8032D-C	80	32	20	\$20.00	In Stock

BLACK PIPE HINGES

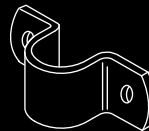
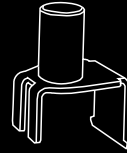
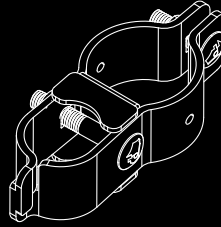

MODEL PIPE HINGE FINISH GALVANISED + BLACK POWDER COAT

CODE	POST (NB)	GATE (NB)	CTN QTY	LIST PRICE	AVAILABILITY
TH5025-C	50	25	20	\$17.00	In Stock
TH8025-C	80	25	10	\$21.00	In Stock
TH10025-C	100	25	10	\$28.00	In Stock
TH10032-C	100	32	10	\$28.00	In Stock

MODEL GUDGEON ATTACHMENT FINISH GALVANISED + BLACK POWDER COAT

CODE	GATE (NB)	CTN QTY	LIST PRICE	AVAILABILITY
HAP25-C	25	20	\$19.84	In Stock
HAP32-C	32	10	\$20.79	In Stock

Used with Pipe Hinge (above).

MODEL TIGHT-FIT STRAP HINGE FINISH GALVANISED + BLACK POWDER COAT

CODE	PIPE (NB)	PIPE (MM)	CTN QTY	LIST PRICE	AVAILABILITY
S4T-C	32	40	30	\$6.80	To Order
S5T-C	40	40	30	\$7.89	To Order
S6T-C	50	40	30	\$8.65	To Order

BLACK

LATCH : CATCH

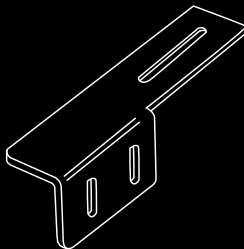
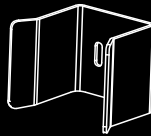
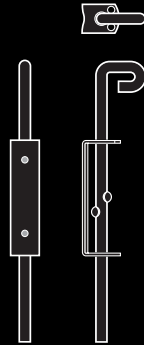
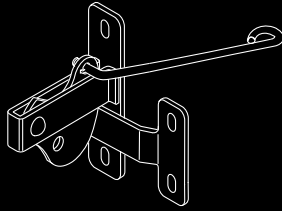

MODEL DEE LATCH PACK - BOLT-ON FINISH ZINC PLATED + BLACK POWDER COAT

CODE	CTN QTY	LIST PRICE	AVAILABILITY
DLKPP-C	30	\$13.00	In Stock

Includes, latch, striker & heavy-duty 6mm thick handle

MODEL 400MM DROP BOLT - LOCKABLE FINISH ZINC PLATED + BLACK POWDER COAT

CODE	CTN QTY	LIST PRICE	AVAILABILITY
B15L-C	20	\$23.00	In Stock

MODEL SLIDE GATE CATCH FINISH ZINC PLATED + BLACK POWDER COAT

CODE	GATE (MM)	CTN QTY	LIST PRICE	AVAILABILITY
SGC-50-C	50	20	\$28.20	In Stock
SGC-75-C	75	20	\$34.20	In Stock
SGC-100-C	100	20	\$40.10	In Stock

MODEL SLIDE GATE TOP GUIDE ROLLER BRACKET FINISH ZINC PLATED + BLACK POWDER COAT

CODE	SIDE	LIST PRICE	AVAILABILITY
SGBR-C	Right	\$16.10	In Stock
SGBL-C	Left	\$16.10	In Stock

All Finishes: Chain Wire Fittings

MODEL TEE BASE FINISH HOT DIP GAL

HOT DIP GALVANISED	BLACK OVER HOT DIP GAL
T2525	T2525-C
T2532	T2532-C
T2540	T2540-C
T3225	T3225-C
T3232	T3232-C
T3240	T3240-C
T3250	T3250-C
T4025	T4025-C
T4032	T4032-C
T4040	T4040-C
T4050	T4050-C
T5025	T5025-C
T5032	T5032-C
T5040	T5040-C
T5050	T5050-C
T8025	T8025-C
T8032	T8032-C
T8040	T8040-C
T8050	T8050-C

MODEL CROSS BASE FINISH HOT DIP GAL

HOT DIP GALVANISED	BLACK OVER HOT DIP GAL
X2525	X2525-C
X2532	X2532-C
X2540	X2540-C
X2550	X2550-C
X3232	X3232-C
X3240	X3240-C
X3250	X3250-C
X4040	X4040-C
X4050	X4050-C
X5050	X5050-C

MODEL ADJUSTABLE CORNER BASE FINISH HOT DIP GAL

HOT DIP GALVANISED	BLACK OVER HOT DIP GAL
AC3232	AC3232-C
AC3240	AC3240-C
AC3250	AC3250-C
AC4040	AC4040-C
AC4050	AC4050-C
AC5050	AC5050-C
C3250	C3250-C
C4040	C4040-C
C4050	C4050-C

MODEL CORNER BASE FINISH HOT DIP GAL

HOT DIP GALVANISED	BLACK OVER HOT DIP GAL
C2525	C2525-C
C2532	C2532-C
C2540	C2540-C
C2550	C2550-C
C3232	C3232-C
C3240	C3240-C
C3250	C3250-C
C4040	C4040-C
C4050	C4050-C

MODEL UNIVERSAL FITTINGS BASE FINISH HOT DIP GAL

HOT DIP GALVANISED	BLACK OVER HOT DIP GAL
UFFB25	UFFB25-C
UFFB32	UFFB32-C
UFFB40	UFFB40-C
UFFB50	UFFB50-C
UFFT25	UFFT25-C
UFFT32	UFFT32-C
UFFT40	UFFT40-C
UFFT50	UFFT50-C
UFFT65	UFFT65-C
UFFT80	UFFT80-C
UFFT100	UFFT100-C
UFFT150	UFFT150-C
UFFMPC	UFFMPC-C
UFFWB	UFFWB-C

All Finishes: Caps

MODEL CAST ALLOY SQ. CAP BASE FINISH RAW

RAW	BLACK POWDER COAT
PC5	PC5-C
PC6	PC6-C

MODEL STEEL ROUND CAP BASE FINISH HOT DIP GAL

HOT DIP GALVANISED	BLACK OVER HOT DIP GAL
K20	K20-C
K25	K25-C
K32	K32-C
K40	K40-C
K50	K50-C
K65	K65-C
K80	K80-C
K100	K100-C

MODEL STEEL ROUND CAP BASE FINISH GALVABOND

GALVABOND	BLACK OVER GALVABOND
K20GB	K20GB-C
K25GB	K25GB-C
K32GB	K32GB-C
K40GB	K40GB-C
K50GB	K50GB-C
K65GB	K65GB-C
K80GB	K80GB-C
K100GB	K100GB-C
K125GB	K125GB-C
K150GB	K150GB-C
K50MSGB	
K65MSGB	
K75MSGB	
K90MSGB	
K100MSGB	
K125MSGB	
K150MSGB	

All Finishes: Rail Brackets, Hinges, Latches, Catches

MODEL SECURE RAIL BRKT BASE FINISH HOT DIP GAL

HOT DIP GALVANISED	BLACK OVER HOT DIP GAL
SRB620-92	SRB620-92-C
SRBA628-92	SRBA628-92-C
CUSMS	CUSMS-C

MODEL VARIOUS BASE FINISH ZINC PLATING

ITEM	ZINC	BLACK OVER ZINC
Steel Rail Bracket: Dbl lug	DFB4040-2DZ-C	DFB4040-2DZ-C
Steel Rail Bracket: Dbl lug	DFB3825-2DZ	DFB3825-2DZ-C
Steel Rail Bracket: Sgl lug	RFB3825-2Z	RFB3825-2Z-C
Latch	DLKPP	DLKPP-C
Hinge: Adjustable Pin	TGP110	TGP110-C
Hinge	TGP100	TGP100-C
Heavy-duty Hinge	LBGA40	LBGA40-C
Drop Bolt	B15L	B15L-C
Slide Gate Catch	SGC-50	SGC-50-C
Slide Gate Catch	SGC-75	SGC-75-C
Slide Gate Catch	SGC-100	SGC-100-C
Slide Gate Bracket	SGBR	SGBR-C
Slide Gate Bracket	SGBL	SGBL-C

MODEL STRAP HINGE BASE FINISH HOT DIP GAL

HOT DIP GALVANISED	BLACK OVER HOT DIP GAL
S4T	S4T-C
S5T	S5T-C
S6T	S6T-C

MODEL VARIOUS BASE FINISH RAW CAST ALUMINIUM

ITEM	RAW	BLACK OVER ZINC
Rail Bracket	FB38H	FB38H-C
Rail Bracket	FB40P	FB40P-C
Rail Bracket	FB38P	FB38P-C
Rail Bracket	FB38V	FB38V-C
Security Rail Bracket	FB50PDL	FB50PDL-C
Adjustable Rail Bracket	RBA2525	RBA2525-C

Pipe Size Converter

PIPE SIZE (NB)	INTERNAL DIAMETER	EXTERNAL DIAMETER	
15NB	1/2"	21.3 mm	27/32"
20NB	3/4"	26.9 mm	1 1/16"
25NB	1"	33.7 mm	1 11/32"
32NB	1 1/4"	42.4 mm	1 11/16"
40NB	1 1/2"	48.3 mm	1 29/32"
50NB	2"	60.3 mm	2 3/8"
65NB	2 1/2"	76.1 mm	3"
80NB	3"	88.9 mm	3 1/2"
90NB	3 1/2"	101.6 mm	4"
100NB	4"	114.3 mm	4 1/2"
125NB	5"	139.7 mm	5 1/2"
150NB	6"	165.1 mm	6 1/2"



Downee

AUCKLAND

*tel: 09 277 0040
fax: 09 277 0140
sales@downee.co.nz*

*331B East Tamaki Rd
East Tamaki, Auckland*

MELBOURNE

*tel: 03 9300 5160
fax: 03 9311 2030
vicsales@downee.com.au*

*70-72 William Angliss Drive
Laverton North 3026*

ADELAIDE

*tel: 08 8349 7339
fax: 08 8349 7449
sasales@downee.com.au*

*505 Cross Keys Road
Cavan 5094*

PERTH

*tel: 08 9241 7300
fax: 08 9209 3693
wasales@downee.com.au*

*45 Millrose Drive
Malaga 6090*

BRISBANE

*tel: 07 3434 3400
fax: 07 3349 0567
qldsales@downee.com.au*

*18/140 Wecker Road
Mansfield 4122*

SYDNEY

*tel: 02 8785 5800
fax: 02 9725 3488
nswsales@downee.com.au*

*Unit 6, 1002 Canley Vale Road
Wetherill Park 2164*

***downee.com.au
downee.co.nz***